

# Welcome!



TRANSFORMING | EDMONTON  
BRINGING OUR CITY VISION TO LIFE

## Public Involvement for Preliminary Design of SE to West LRT



We are near the end of the Preliminary Design process for the southeast to downtown portion of the line and want your feedback to finalize the design.

**PROJECT PURPOSE:** To develop and finalize the Preliminary Design for a 27 km urban style, low-floor light rail system along the approved corridor (route) from Mill Woods to Lewis Farms.

2009 - 2011:

Development of Concept Plan

2011 - 2012:

Concept Plan Approved by City Council

2011 - 2013:

Preliminary Design and Public Involvement to Support Preliminary Design

FUTURE:

Detailed Design, Construction and Operation

## Concept

Approved by City Council during **Concept** phase:

- Corridor (route) location
- Track alignment (where track fits in the road right-of-way)
- Stop/station/transit centre locations
- Low floor urban-style LRT

Where we are today

## DESIGN PHASE

**Preliminary Design** means refining the City Council-approved Concept Plan (previous study) with a greater level of detail to better understand impacts and opportunities.

Preliminary Design includes:

- Structural aesthetics (visual integration of the system into the existing landscape and adjacent communities)
- LRT stop/station aesthetics
- Landscape architecture aesthetics
- Connectivity to the existing transportation network across all modes of transportation
- Understanding the impacts to stakeholders and working together to mitigate issues where possible
- Plan amendments i.e.: Wagner Station
- Project delivery

# SE to West LRT Corridor



TRANSFORMING | EDMONTON  
BRINGING OUR CITY VISION TO LIFE

- Council approved
- 27 km line with 3 stations, 25 stops
- 6 bridges
  - Over North Saskatchewan River from Muttart Conservatory to Louise McKinney Park
  - Over Groat Road at 104 Avenue
  - Over 170 Street at 87 Avenue
  - Over Anthony Henday at Webber Greens Drive
  - Over Whitemud Drive at 75 Street
  - Over CN/CP rail lines along 75 Street
- 1 pedestrian bridge at Connors Hill
- 1 tunnel between Louise McKinney Park and 102 Avenue
- 2 Park 'n' Ride sites
- 3 Kiss 'n' Ride sites (other sites being considered)
- Integration with 5 transit centres
- 1 Operation and Maintenance Facility



# Edmonton's Low Floor Urban Style LRT

TRANSFORMING | EDMONTON  
BRINGING OUR CITY VISION TO LIFE



- Urban style - City Council's direction for expansion of existing LRT system and new lines (June 2009)
- Benefits of urban style
  - Improves connections between LRT and community
    - Smaller scale stations/stops, spaced closer together
    - Less visual impact - stops are at street level
  - Less impact on community
    - LRT operates with flow of traffic in its own right-of-way using regular traffic signals (does not have full priority), separated by a curb
    - Fewer barriers
    - Reduced speeds in congested areas to support safe pedestrian oriented communities
  - Encourages pedestrian access
    - Pedestrian crossings at signalized intersections
  - Better links to destinations with more bus, pedestrian and cyclist connections
    - Bike parking at all LRT stops/stations
    - Bus network modified to ensure integrated transit network
  - Investment in landscaping, streetscaping and architectural features to improve visual appeal, where possible
  - Openness of space maximized to create safe environment using Crime Prevention through Environmental Design (CPTED) principles



## Concept Planning: 2009 - 2011

## Preliminary Design: 5 Stages of Public Involvement

- |   |                               |
|---|-------------------------------|
| <b>Stage 1: Pre-Consultation:</b> Developing the public involvement process   | <b>Feb. 2012</b>              |
| <b>Stage 2: Initiation:</b> Envisioning the look, feel and integration of LRT in your community   | <b>Mar. - May 2012</b>        |
| <b>Stage 3: Consultation:</b> Developing the look, feel and integration of LRT in your community  | <b>May - Nov. 2012</b>        |
| <b>Stage 4: Refinement:</b> Refining the look, feel and integration of LRT in your community  | <b>Sept. 2012 - June 2013</b> |
| <b>Stage 5: Conclusion:</b> Presenting the final recommended Preliminary Design—the look, feel and integration of LRT in your community | <b>Jan. - Dec. 2013</b>       |



# Thanks for Getting Involved!



TRANSFORMING | EDMONTON  
BRINGING OUR CITY VISION TO LIFE

Thousands of comments were received during public involvement:

- Public meeting discussions
- Comment forms
- Online survey
- Letters and emails

This input informs Preliminary Design and has been incorporated into materials presented tonight.

## How your input is used:

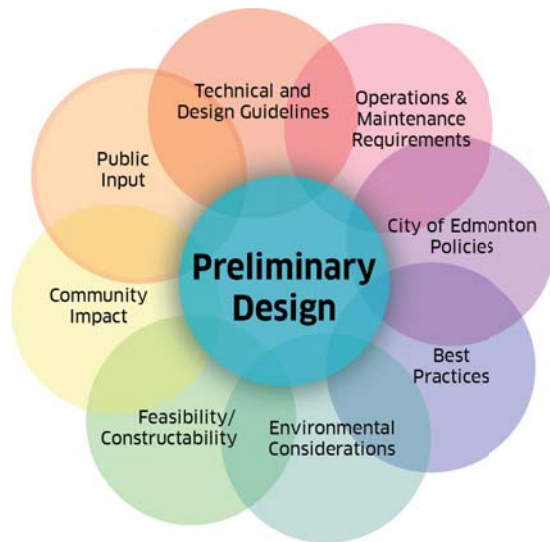

Your input is valuable and used along with other information to finalize the design.

Continued Preliminary Design has input from each of these sources.

# What We Heard from Stage 3



## What We Heard

### Stops

- Stakeholders confirmed the vision for all stops and stations, with a minor change to Millbourne Stop.
- Stakeholders chose themes for a variety of stop/station elements, such as benches and paving.

### North Saskatchewan River Bridge

- Of six bridge options, stakeholders evenly preferred a signature bridge or a contemporary bridge with less visual impact.

### Shelter Canopies

- Of three shelter canopy options, stakeholders preferred the organic shaped canopy.

### Connors Pedestrian Bridge

- Stakeholders preferred the new, angled alignment over the existing bridge alignment over Connors Road.
- Stakeholder opinions were equal on the two bridge concepts: steel plate girder and steel box girder.

### Pedestrian Crossings

- Stakeholders value pedestrian access and want information on how they will navigate the LRT corridor.

### Vehicular Access

- Stakeholders voiced concerns about vehicular access to businesses and residences along the LRT corridor.

### Bicycle Parking

- Stakeholders value bike parking at stops and stations for multi-modal trips.
- Stakeholders value cyclist access between the LRT corridor and the existing City of Edmonton bike network.

### Portal - 102 Avenue

- Stakeholders want an aesthetically-pleasing, safe portal area in Chinatown.

### River Valley

- Stakeholders value Edmonton's river valley and its ecology.

### Noise

- Stakeholders voiced concerns about noise from the operation of the LRT.

### Vibration

- Stakeholders voiced concerns about vibration during construction and operations.

## How the Information is being used

- We modified the Millbourne Stop theme from "Asian" to "Park".
- The preferred themes for stop/station elements are shown on the Stage 4 Stop Theme boards. These are not final selections, but provide direction to the designers.
- We've used your feedback, technical requirements and cost considerations to create a shortlist of three bridges. City Council will consider these factors in choosing one bridge this fall.
- This type of shelter canopy will be used at LRT stops.
- The new alignment is being incorporated into the design.
- We've assessed these bridge options further and have arrived at a design as proposed on the Connors Road Pedestrian Bridge board.
- We've illustrated new, retained and relocated pedestrian crossings on the Corridor & Access Plans. Accommodating pedestrians is a priority of this project.
- We've illustrated new, retained and relocated vehicle accesses on the Corridor & Access Plans.
- Bicycle parking will be provided at each stop/station and may include public art opportunities. Exact locations will be determined later in the project.
- We've illustrated local connections to the City of Edmonton cycling network on the Corridor & Access Plans. These connections will be refined as the cycling network grows and as preliminary design continues.
- We're designing this area in cooperation with the Quarters Redevelopment Project. Our team will continue design of the portal and the Quarters team will continue to design the spaces around the portal.
- We're continuing to work with the Muttart Conservatory and other City departments to provide a high level of rehabilitation of the natural and ornamental planting in the river valley, and to provide screening where possible.
- A review of the noise assessment from the concept plan is ongoing. See the Noise Impact Board.
- General vibration screening is ongoing. Pre-construction assessment of structures and houses abutting the LRT route may be completed. See the Vibration Impact Assessment board.



Organic canopy will be used at LRT stops



Bicycle parking incorporating public art

# Thanks for Getting Involved!



TRANSFORMING | EDMONTON  
BRINGING OUR CITY VISION TO LIFE

## What kind of feedback are we looking for?

- Look/feel of stop/station (landscape architecture, colours, treatment)
- Important connections/access points
- Confirmation of how amenities will look

## What kind of feedback are we unable to use?

- Comments about decisions made in Concept Planning (route, stop/station locations, vehicle technology)
- Comments about elements that cannot be addressed until later phases of project
- Comments regarding elements outside of the scope of project

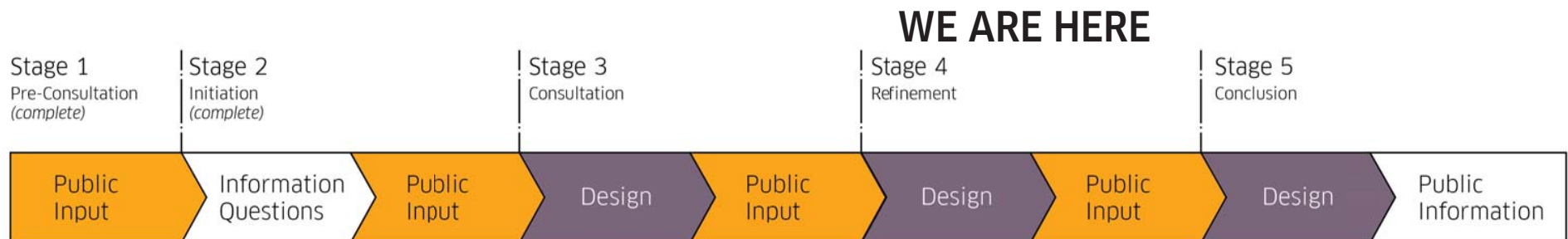



# SE to West LRT Facts



TRANSFORMING | EDMONTON  
BRINGING OUR CITY VISION TO LIFE

- Corridor (route) approved by City Council
- 27 km route runs from Mill Woods (southeast) to Lewis Farms (west)
- Vertical connection with existing LRT at Churchill Station downtown
- Trains are low floor technology - stops at street level, minimizes impact to community, less infrastructure required at stops/stations
- Trains run on approximately 5 minute intervals during peak hours
- Trains do not share a right-of-way with other road users, but do share traffic signals
- A complementary bus network is being reviewed – some existing bus stops may be relocated to better integrate with LRT
- Preliminary Design scheduled to be complete by late 2013 – Detailed Design and Construction to follow subject to funding approval
- Construction of the entire 27 km SE to West LRT will begin in southeast due to location of Operations and Maintenance Facility
- City Council priorities for LRT construction:
  - Downtown to NAIT (opening 2014)
  - SE to West LRT
- The City will implement a strategy for snow removal



# Did You Know? Interesting Facts



TRANSFORMING | EDMONTON  
BRINGING OUR CITY VISION TO LIFE

- Significant environmental studies being conducted and include assessments of rare plants, bird and wildlife habitats, animal corridors, groundwater and the North Saskatchewan River.
- Noise and vibration studies conducted in potentially affected areas along route including residential, commercial and industrial areas, as well as in the Winspear Centre for Music and Citadel Theatre areas.
- The City of Edmonton's Corporate Tree Management policy is referenced to aid in determining value of trees and how value is replaced, if required.



*Team brings rail transit experience from around the world*

- 32 individual disciplines bring rail transit expertise from around the world to the Preliminary Design project, including:
  - Civil, structural, electrical, rail and geotechnical engineers
  - Landscape architects
  - Environmental scientists, biologists, botanists and wildlife experts
  - Urban designers
  - Architects
  - Urban Planners
  - Finance experts

# Park 'n' Ride, Kiss 'n' Ride & Transit Centres



## PARK 'N' RIDE

Car park connected to transit station that allows commuters to leave vehicles and transfer to bus or LRT.

## KISS 'N' RIDE

A place where commuters are driven and dropped off at a bus or LRT stop/station. Other Kiss 'N' Ride locations are being determined.

## TRANSIT CENTRE

A stopping point for bus and LRT where commuters can move from one transit mode to the other.

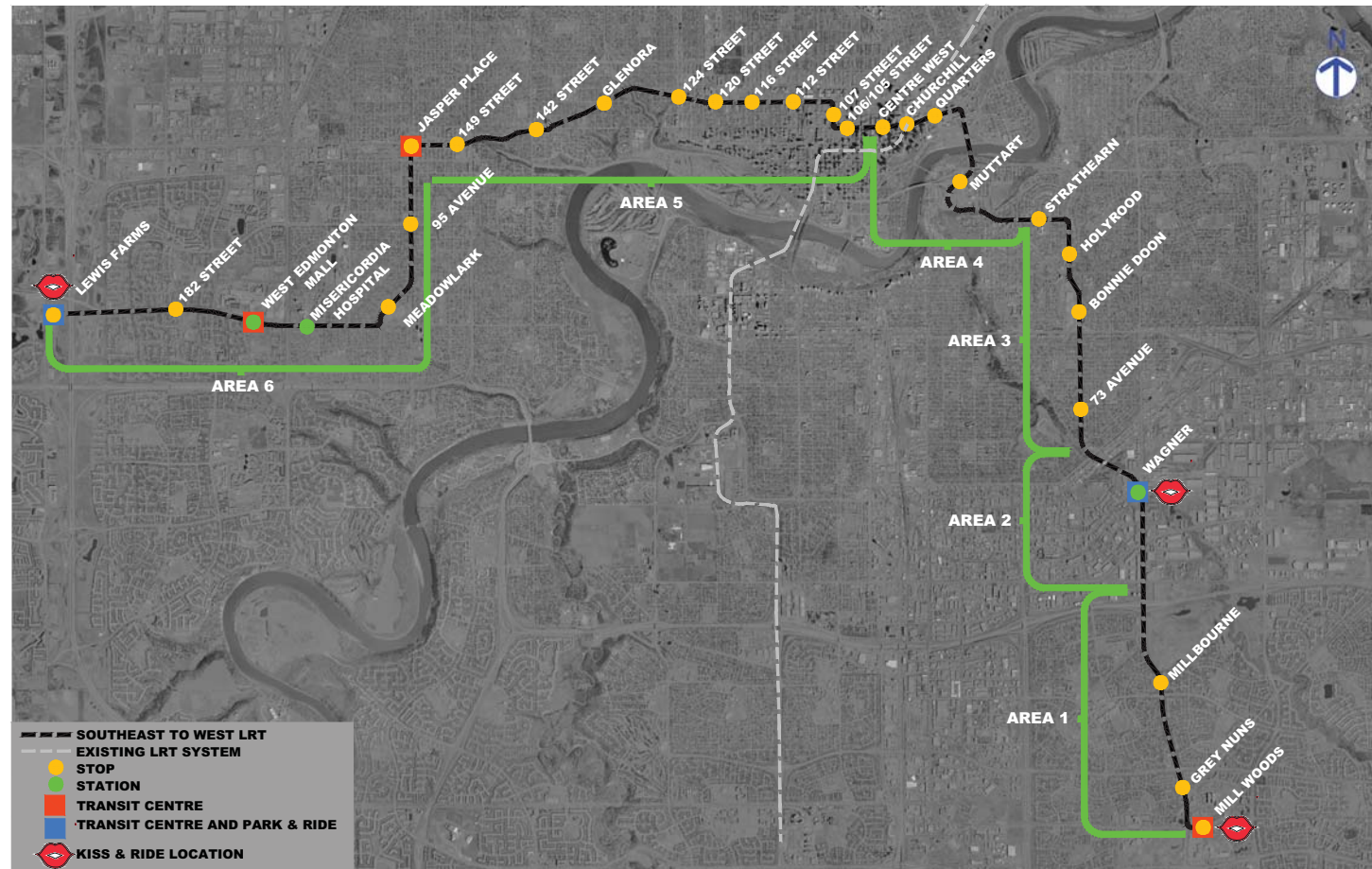

# Stop Elements



TRANSFORMING | EDMONTON  
BRINGING OUR CITY VISION TO LIFE

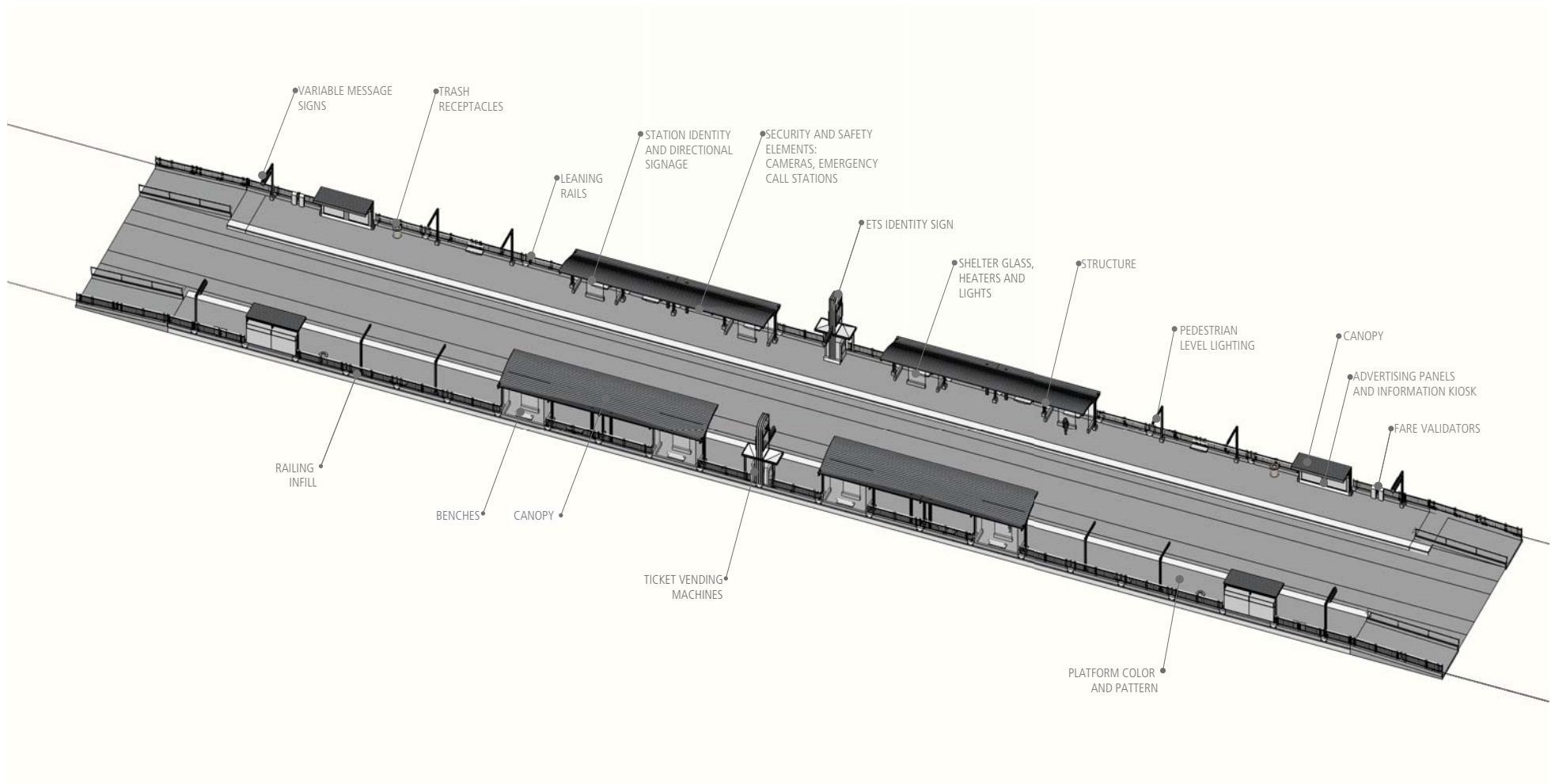

- All layouts and scale to be confirmed as design progresses, based on ridership projections



# Stop Layouts

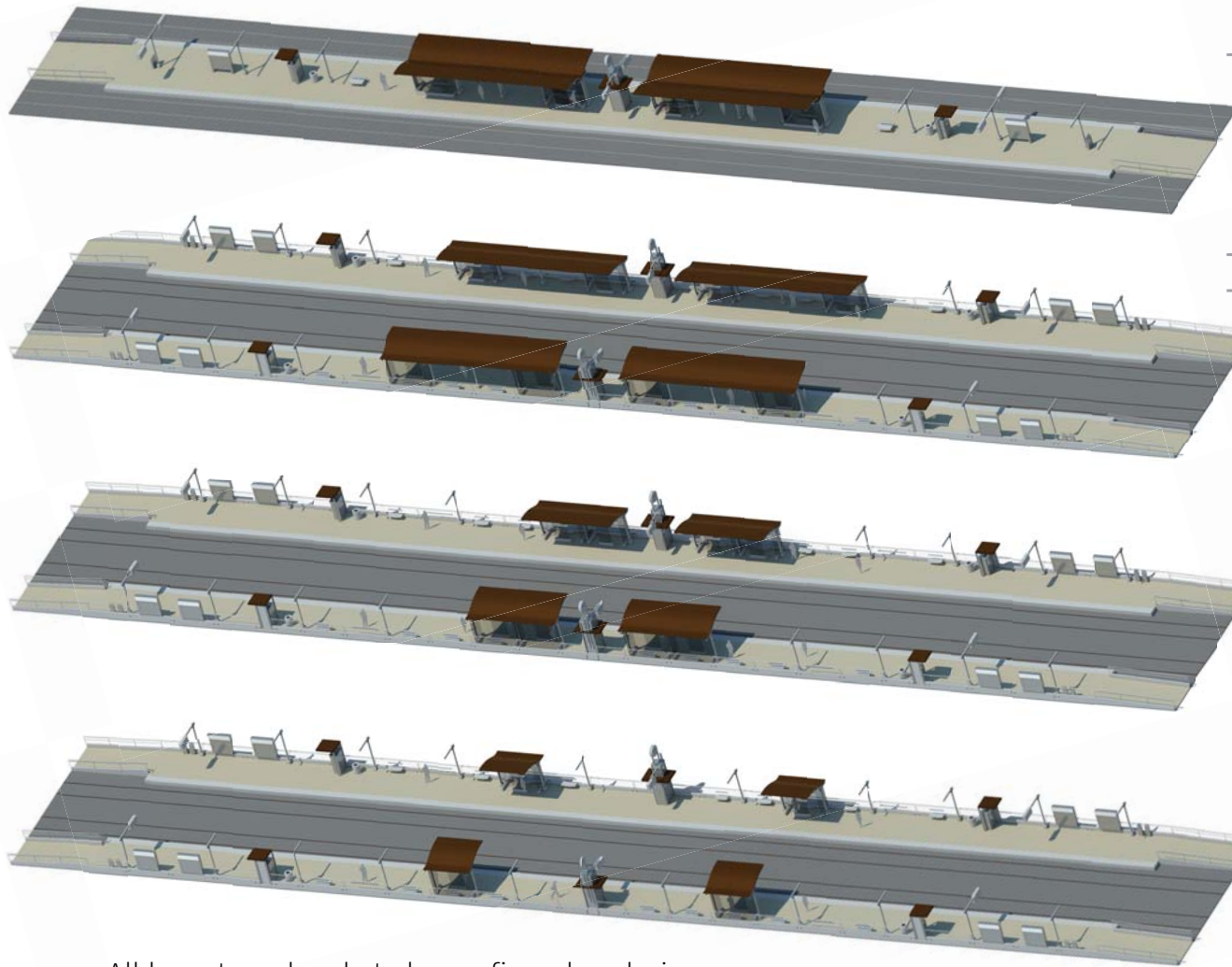

- Stop types (Centre or Side) were determined in the approved Concept Plan.

- Centre loading

- Side loading

- All layouts and scale to be confirmed as design progresses, based on ridership projections





## We Heard:

Organic form is preferred by the public.

Organic form that recalls the river and natural history of the area.

### Materials:

- Steel structure
- Metal and wood canopy
- Glass shelters
- Unique concrete finishing on platform



# Approved Concept Plan Amendment



TRANSFORMING | EDMONTON  
BRINGING OUR CITY VISION TO LIFE

## Original Concept Plan (2011)

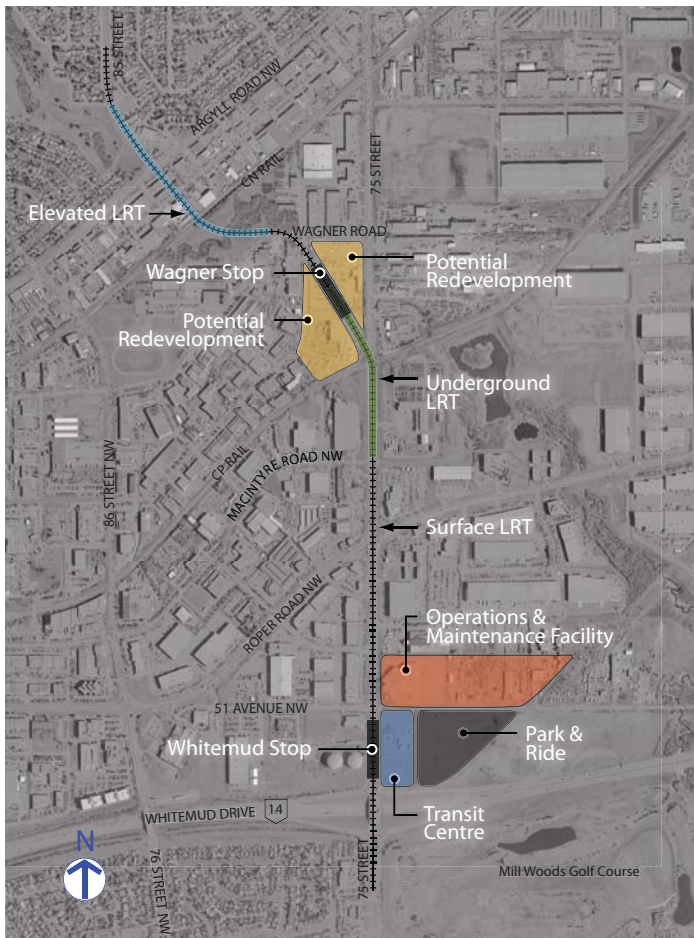

## Approved Amendment to Concept Plan (July 2012)

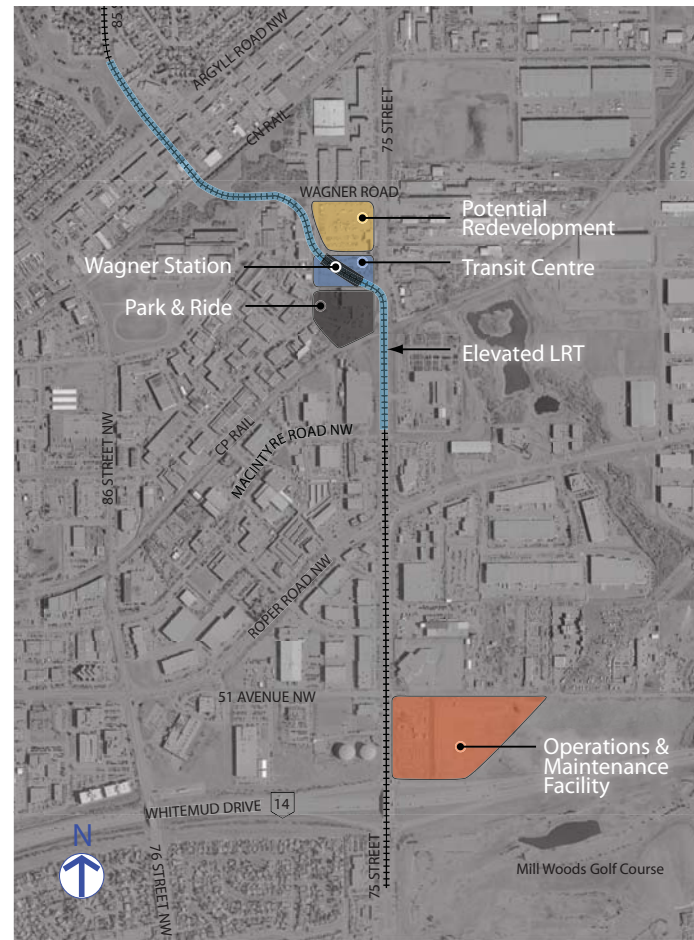

- Amendment approved by City Council July 2012:
  - Whitemud stop removed
  - Wagner stop changed to elevated station and Park 'n' Ride
  - Operations and Maintenance Facility moved South of 51 Avenue



The Operations and Maintenance Facility (OMF) is where LRT vehicles are cleaned, serviced and stored. This will be one of the first facilities to be built on the line to provide the necessary storage and maintenance areas.

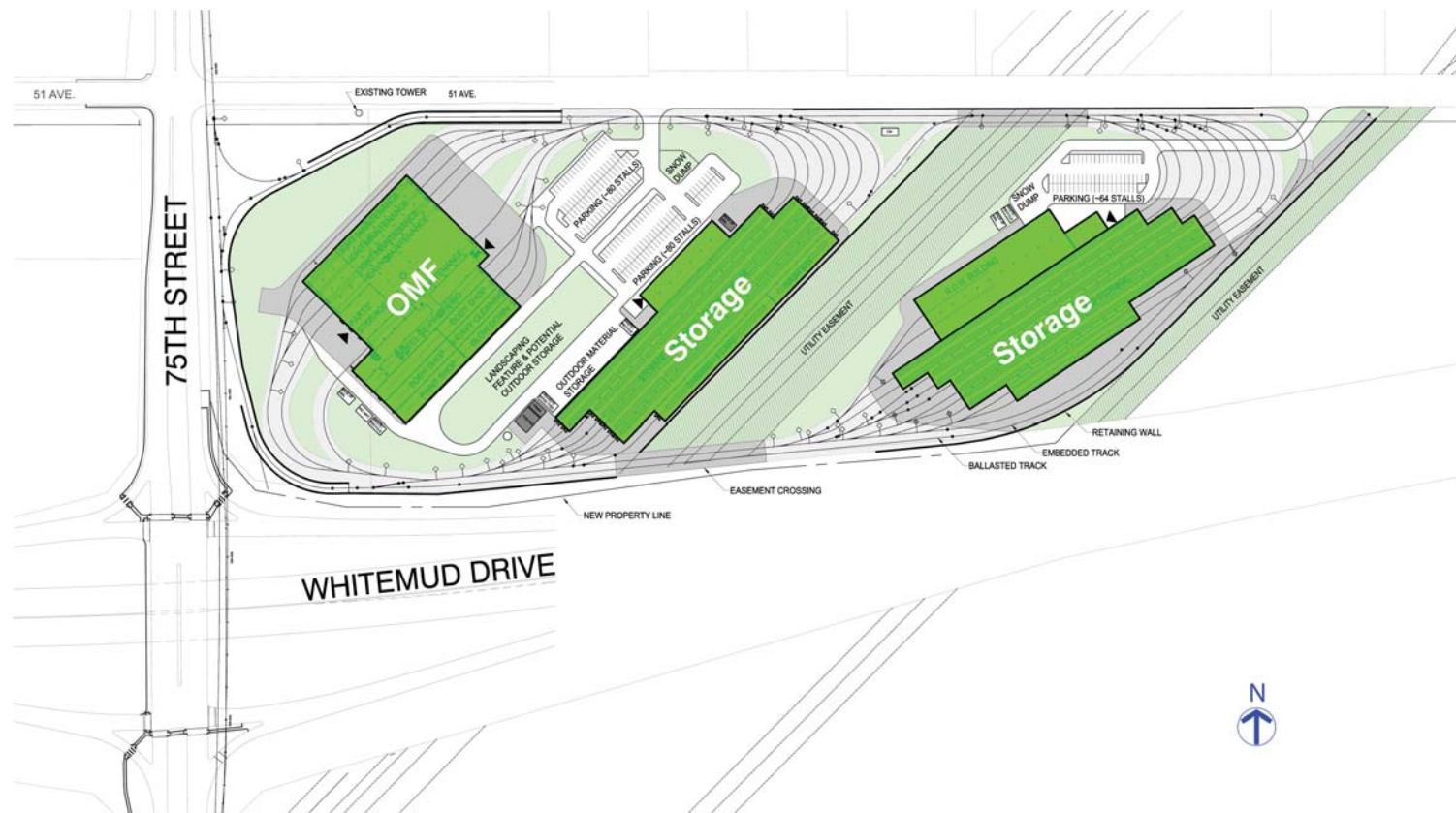

- Facility configuration will be refined during detailed design





# Public Art



TRANSFORMING | EDMONTON  
BRINGING OUR CITY VISION TO LIFE

- Public art is considered to be a key component to attractiveness and identity of city
- Public art demonstrates:
  - Character of communities
  - Investment in the arts
- Public art strengthens local economy
- Support for arts is a reflection of a progressive municipality
- The City dedicates 1% of qualifying construction budgets to public art
  - Program operated by Edmonton Arts Council
- Approved public art will be displayed within or in close proximity to publicly accessible municipal property
- Input received during Preliminary Design regarding public art will be provided to the Edmonton Arts Council
- Through the Edmonton Arts Council, the public has an opportunity to:
  - Help select an artist to provide art along LRT corridor (route)—typically at stations
  - Potentially provide ideas for artist's consideration



*Integrated public art at transit stops.*

# Traction Power Substations (TPSS)



Priority is to locate substations on City property

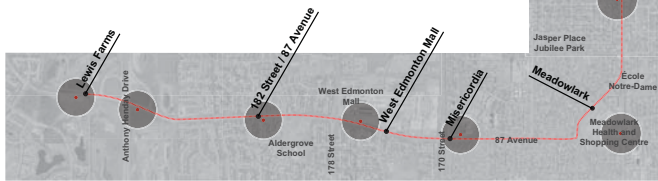

SE to West LRT Alignment and TPSS Locations

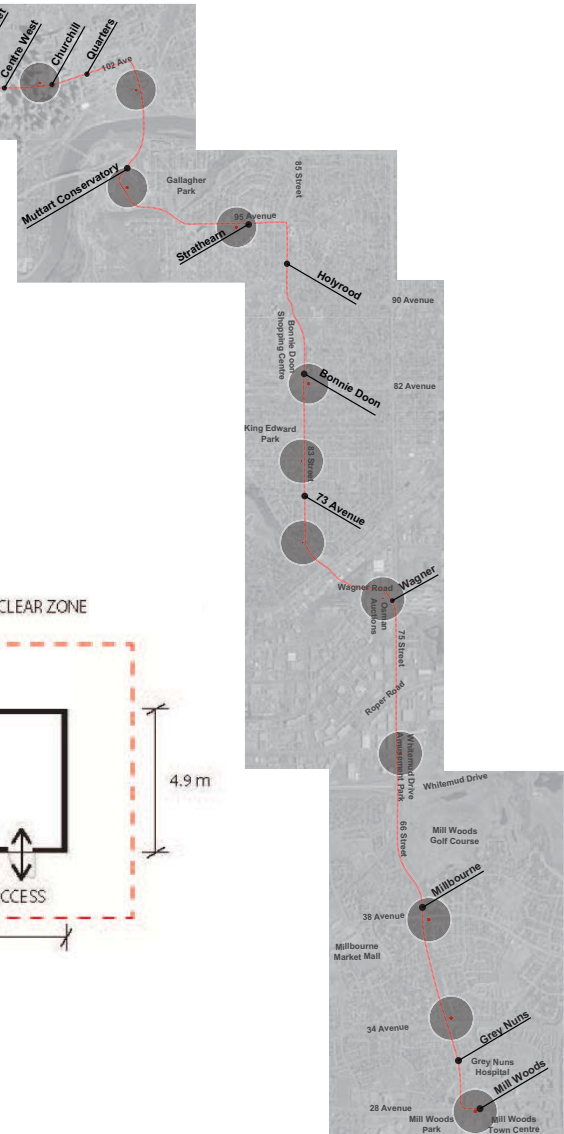
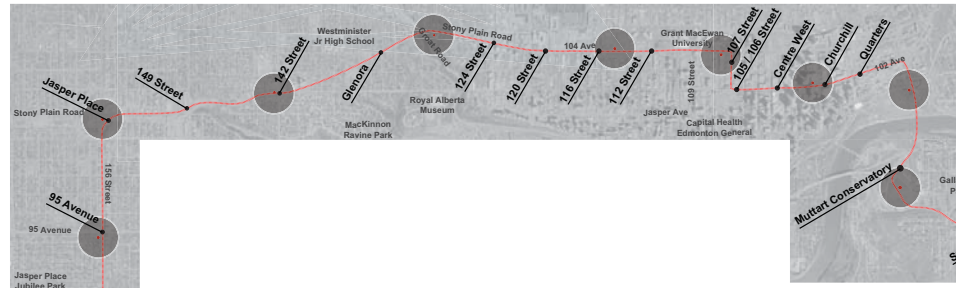

- The purpose of the traction power substation is to convert and regulate power to the LRT vehicle
- TPSS must be located approximately every 1 km (0.62 mile) along the corridor
- Some locations will receive pre-manufactured units, other locations may require traction power substations to be built in place
- See Corridor Access Plan for approximate locations

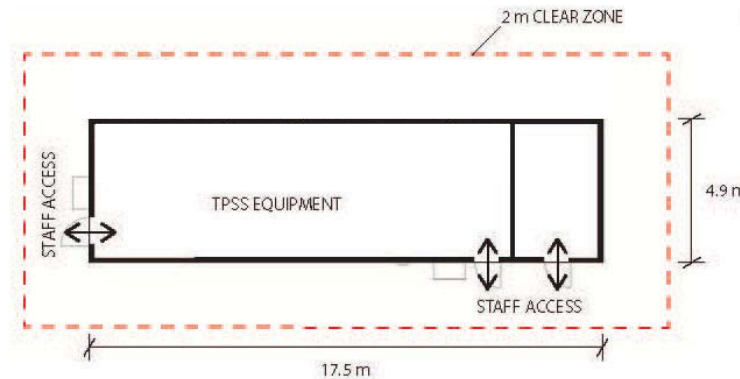

Typical Pre-Manufactured Unit





# Traction Power Substations (TPSS)



TRANSFORMING | EDMONTON  
BRINGING OUR CITY VISION TO LIFE

## Examples of potential TPSS screening



- Screening (fencing, walls) will blend with neighbourhood aesthetic
- Landscaping will further screen site



Noise modeling is being conducted in keeping with the City's Urban Traffic Noise Policy along the LRT corridor.

## City of Edmonton Urban Traffic Noise Policy (UTNP)

- City seeks to achieve a projected attenuated noise level below 65 dBA Leq24 (traffic noise over a 24 hour period)
- If predicted noise level is 65 dBA Leq24 or greater, a noise barrier may be provided

## Traffic Noise Measurement

- Traffic noise levels are measured in decibels (dBA) over several days and averaged for 24 hour period (Leq24)

## Noise Modeling

- Projected volumes based on proposed lane configurations, addition of LRT and future traffic growth
  - Assess projected noise levels against the UTNP
  - Based on 2044 figures—a horizon year used throughout the project
- Review of noise assessment from Concept Plan is ongoing

### FAMILIAR NOISES                      dBA

Inside average urban home	50
Quiet street	50
Normal conversation at 1 m	60
Noisy restaurant	70
Highway traffic at 15 m	75
Busy traffic intersection	80
Bus or heavy truck at 15 m	88-94
Jackhammer	88-98
Freight train at 15 m	95
Jet taking off at 600 m	100
Amplified rock music	110

# Vibration Impact Assessment

TRANSFORMING | EDMONTON  
BRINGING OUR CITY VISION TO LIFE



- Vibration could occur during LRT construction and operation
- LRT runs on a continuous welded rail, a technology that minimizes vibration during operation
- A complete vibration screening of the SE to West corridor (route) is being conducted as part of Preliminary Design
- Vibration screening is based on the US Federal Transit Administration (FTA) screening process
- Corridor Wide Assessment is ongoing
  - Screening based on general vibration assessment
  - Accounts for train type, speed, distance from track
  - Screens out residences not affected by vibration
  - Identifies areas that may be affected
- Detailed Vibration Assessment
  - Includes site specific vibration measurements
  - Conducted at Winspear Centre for Music and Citadel Theatre areas (acoustic sensitivities)
  - Recommendations to reduce vibration during LRT operations will be provided if warranted
- Pre-construction assessments of structures and houses abutting the LRT route may be completed

- Mitigating environmental impacts is significant throughout all phases of the project
- Environmental impact assessments are nearing completion by a team that includes soil, water quality and air quality scientists; biologists; archaeologists; socio-economic and noise/vibration specialists



## Environmental Site Assessments

- Determine if contaminated sites or potentially hazardous materials will be encountered during construction
- Includes soil and groundwater studies
- Assist in providing for safety of construction workers, public and environment

## Environmental Impact Assessment

- Required by Edmonton's North Saskatchewan River Valley Area Redevelopment Plan (Bylaw 7188) and may be required by Canadian Environmental Assessment Act 2012
- Includes describing soils, water quality, water courses, wildlife, vegetation, rare species, natural areas, ecological connectivity, archaeological, paleontological and socioeconomic resources in the vicinity of LRT and assessing impacts of construction and operation
- Investigations will include effects of noise, dust and vibrations on local community assets
- Information will be used to:
  - Inform design and construction
  - Obtain required approvals from other jurisdictions such as Fisheries and Oceans Canada and Transport Canada

## Natural Area Assessment and Management Plan

- For all natural areas impacted by the project

## Geotechnical Studies

- Assess ground conditions to determine suitability for construction
- Provide design advice on stability of slopes for foundations, tunnels, chambers and other structures



# Overhead Catenary Support Systems (OCS)



TRANSFORMING | EDMONTON  
BRINGING OUR CITY VISION TO LIFE

Overhead catenary poles provide power to the LRT vehicle. They are either located in the centre or on the side of the route. This location is determined by the space available and technical requirements.



*Examples of potential catenary poles*





# Thank You



TRANSFORMING | EDMONTON  
BRINGING OUR CITY VISION TO LIFE

## Thank you for your input!

Your input from tonight's session will be provided to Preliminary Design team and available online at [www.edmonton.ca/LRTprojects.ca](http://www.edmonton.ca/LRTprojects.ca)



We hope to see you during [Stage 5 - Conclusion](#)

Areas 1-4      February 2013

Areas 5-6      2013

# Wagner Station: Theme



TRANSFORMING | EDMONTON  
BRINGING OUR CITY VISION TO LIFE



Elements below reflect  
What We Heard from Stage 3



ELEMENTS  
SIMILAR  
TO THESE:



BENCHES



GARBAGE BINS



RETAINING WALLS



PAVING



COLUMN WRAPS



RAILING

# Wagner Station

TRANSFORMING | EDMONTON  
BRINGING OUR CITY VISION TO LIFE



Aerial view looking South



Aerial view looking North

Concept only - design is ongoing

Wagner Station includes:

- Park 'N' Ride
- Kiss 'N' Ride
- Transit Centre
- Potential for future Transit Oriented Development (T.O.D.)



View from Kiss 'N' Ride area looking towards station



# Argyll Bridge



TRANSFORMING | EDMONTON  
BRINGING OUR CITY VISION TO LIFE



*Argyll Road looking Southwest*



*83 Street looking South*



*Argyll Road looking Northeast*

Preliminary design of all structures is ongoing.